

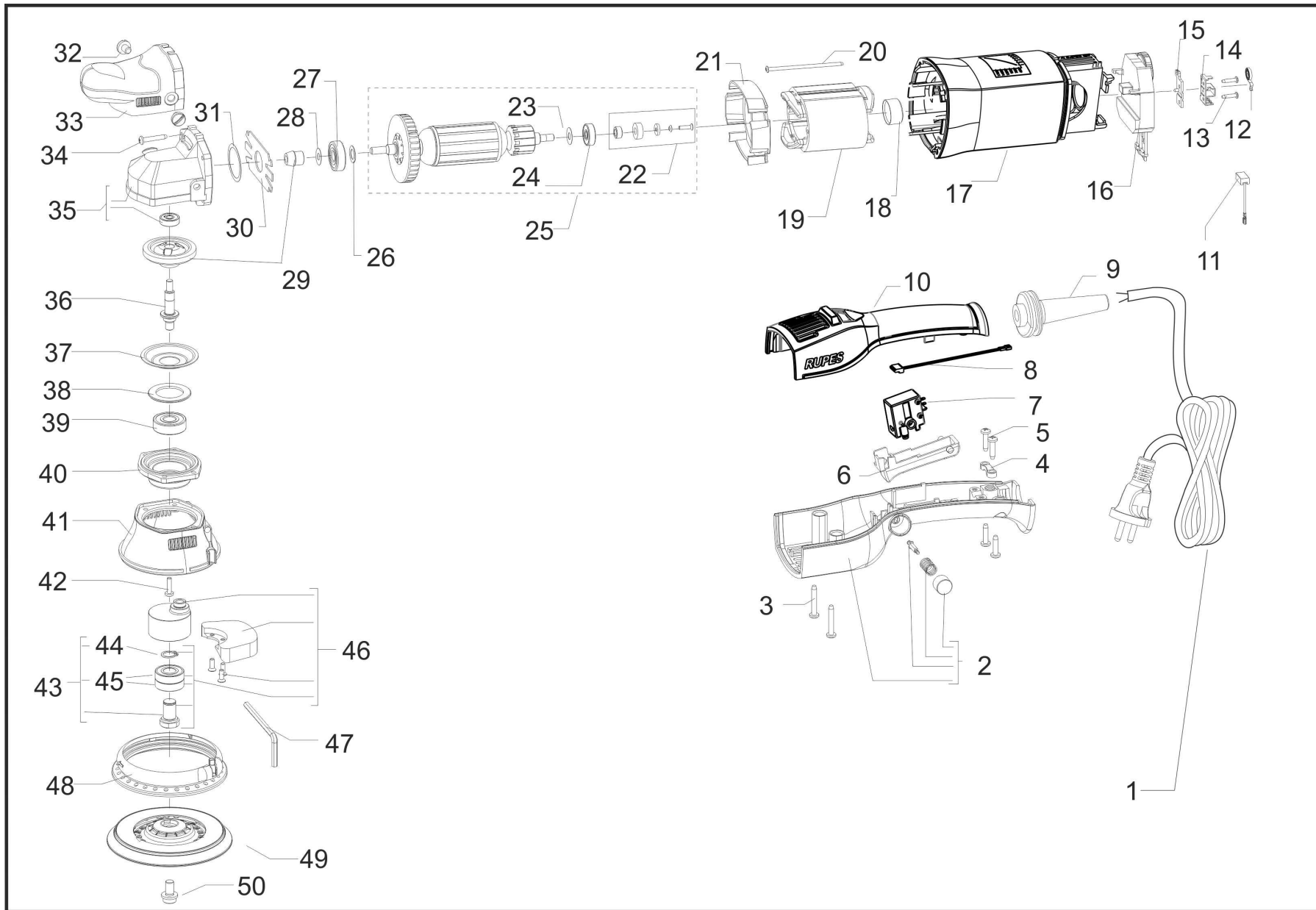







# RUPES











LUCIDATRICE ROTORBITALI  
RANDOM-ORBITAL POLISHER













## LHR21III





Point	Code	Beschreibung
001	9C2X0,8VUS9	CAVO 2x18AWG spina AMERICANA polarizzata R21 9mt.
001	9C2X1,0NGB9FOR	KABEL 2X1 (Stecker UK) mit Gabel H07RN-F ZENTRALE METALL STECKER mt.9

	Point	Code	Beschreibung
	001	9C2X1,0NAU9FOR	KABEL 2X1 (Stecker Australien) H07RN-F mt.9
	001	9C2X1,25VJA9	KABEL 2x1,25 (Stecker JAPAN) mt.9
	001	9C2X1,0RCN9	CAVO 2x1 (CCC) (spina Cina) mt.9
	001	9C2X1,0R409FOR	KABEL 2X1 (Stecker D4) H07RN-F mt.9 mit Gabel (nur Schweiz)
	001	9C2X1,0N489	KABEL 2X1 (Stecker Schuko d4,8) mt.9 H07RN-F FLEX
	002	44.374/C	KOMPLETT UNTERE HANDGRIFF
	004	442.55	KABELKLEMME
	005	9.660	SCHRAUBE 3,9x16 ( 7x5/8") T.C.C.
	006	38.374/C	SCHALTER TASTE
	007	45.372	FORTLAUFEN SCHALTER
	008	408.374/C	KABELSTRANG
	009	42.290	KABELSCHUTZ
	010	441.374/C	IMPUGNATURA GOMMATA SUPERIORE COMPLETA
	011	47.105/10	BLISTER MIT 10 STK. BUERSTEN BA215
	012	461.105	FEDER BUERSTENHALTER BA21 BRUNIERT
	013	9.551	SCHRAUBE 2,9x13 ( 4x1/2") T.C.C.
	014	46.105	BUERSTENHALTER BA215-LH18ENS
	015	462.105	B RSTENHALTER PLATTE
	016	400.394/60HZ/C	ELEKTRONIKMODUL LHR21III 60HZ
	016	400.394/C	ELEKTRONIKMODUL
	017	31.394/C	MOTOR BLOCK LHR21 MARK III

	Point	Code	Beschreibung
	018	268.105	LAGER KAPPE
	019	2.394/100S	STATOR (V.100)
	019	2.394/120S	STATOR (V.120)
	019	2.394/230S	STATOR (V.230)
	020	9.787	SCHRAUBE 2,9x70 T.C.C.
	021	73.322	LUFT SCHOTT
	022	405.322/C	KOMPLETTE MAGNET
	024	9.14/10	LAGER 626 ZZ
	025	1.382/120S/C	ROTOR (ARMATURE) 120V
	025	1.382/230S/C	ROTOR 230V
	025	1.382/100S/C	ROTOR (V.100)
	027	9.187/10	LAGER 629 2BRS R66 FA227 ERI
	029	50.245	RITZEL KRANZ
	030	351.105	MOTOR BLOCK KLEINE DECKEL
	031	9.364	STAHL UNTERLEGSCHIEBE d25,9x21 s 0,1
	032	812.91	SCHRAUBE M8 x 15 T.C.IN NYLON A T.

	Point	Code	Beschreibung
	033	814.394/C	KOMPLETT FRONTALGEHÄUSE LHR21 MarkIII
	034	9.679	SCHRAUBE 4,2x25 ( 8x1" ) T.C.C.
	035	32.326/C	GETRIEBE
	036	51.245	SPINDEL WELLE
	037	35.105	FLANSCHDECKEL BA21
	038	54.245	DISTANZSTUECK GETRIEBEKASTEN
	039	9.184/10	LAGER 6201 2BRS R66 FA227 ERI
	040	33.245	FLANSCH
	041	65.245	SCHUTZKAPPE
	042	9.835	SCHRAUBE 3,9x 9,5 T.C.C. GLANZDRUECKEN
	043	56.245N/C	KOMPLETT VORSCHLAGHAMMER ZAPFEN
	044	9.102	SEEGER d 12 TIPO E DIN 471 CR3 PHOSPHATIERT
	045	9.182/10	LAGER NSK 6001 DDWCM J NS75Z
	046	58.245N/C	KOMPLETTE KIPPHEBEL LHR21E

	Point	Code	Beschreibung
	047	9.1395	INBUSSCHL SSEL 5mm
	048	651.245	GUMMI KASTEN
	050	9.715	SCHRAUBEM8 x 16 T.B VERZINKT MIT UNTERLEGSCHIEBE